

## PRODUCT FEATURES

MONODELTA is a single flap smoke vent suitable for the removal of large quantities of warm air and / or smoke from a building within a short period of time, dayly ventilation and natural lighting. Suitable for utilization on shed style roofs. The vents are manufactured according to ISO 9001 quality control standards and comply with the European requirements for NSHE according to EN 12101-2. Endurance tests with 10,000 opening and closing cycles have proven its robust and functional design. The vents are formed from high quality corrosion resistant aluminium to ensure low maintenance requirements and watertightness. Various methods of operation using pneumatic or electric actuators are available. Available on large dimensions, up to 1250 x 3000 mm (width x length).

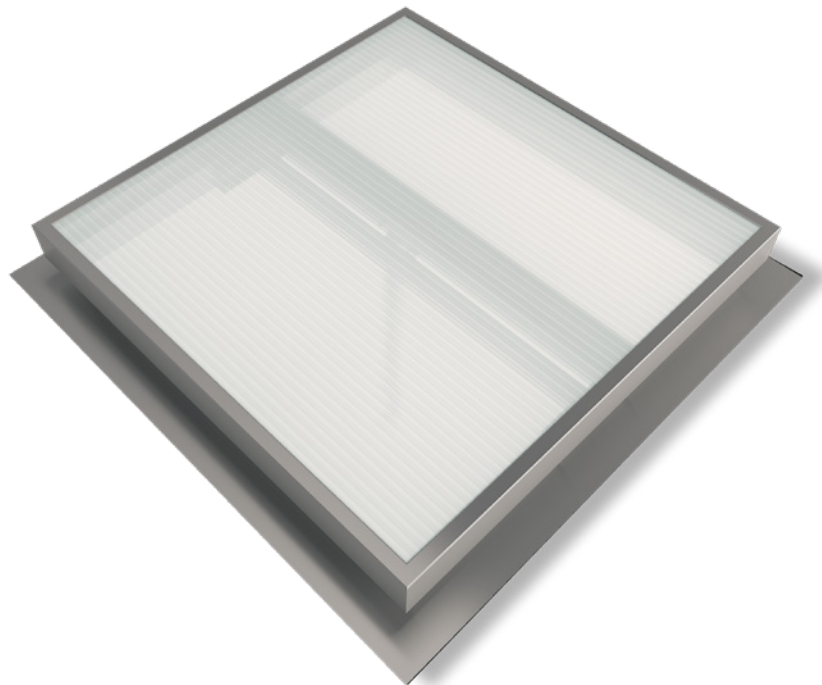

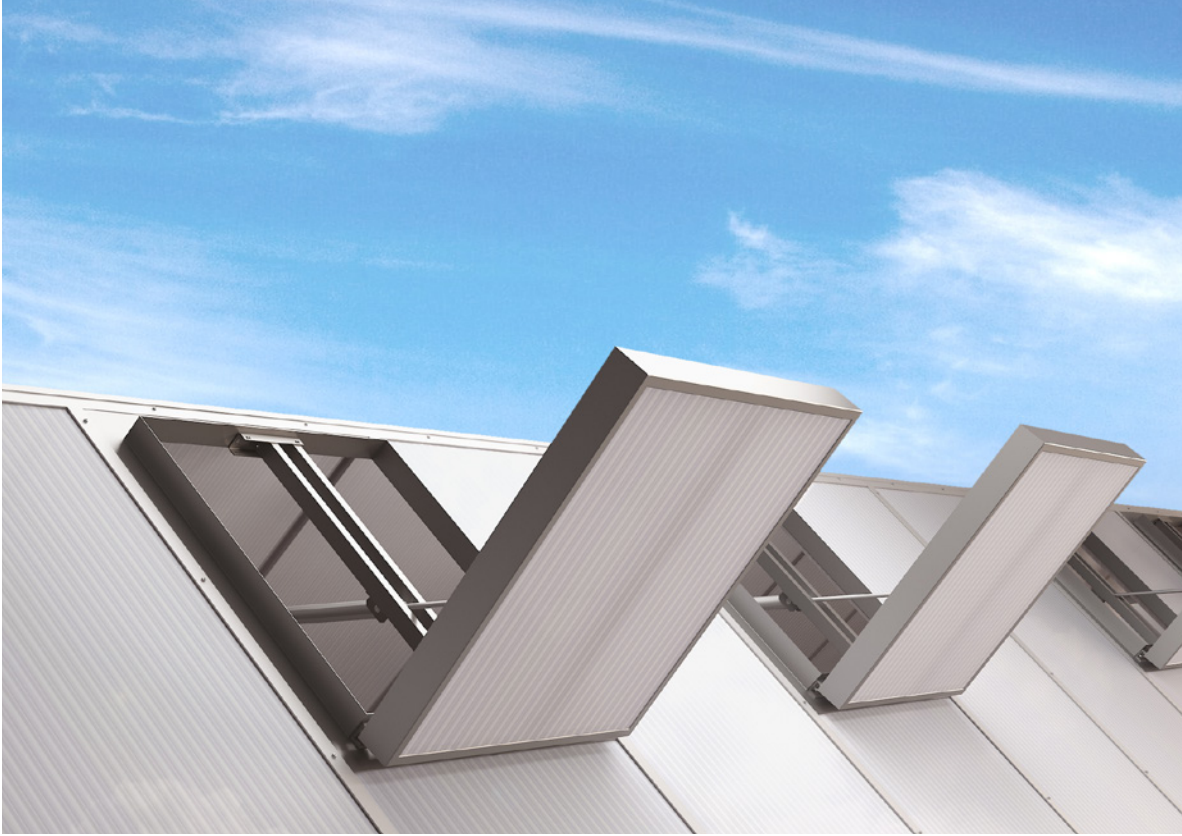

# monodelta

## TYPICAL APPLICATIONS

Shed style roofs: 15/15, 30/30, 45/45

## MATERIALS

Aluminium; tempered, sea water and corrosion-resistant AlMg3 and extruded aluminium profiles for the frames. Corrosion-resistant bearings. The aluminium is supplied untreated as standard. Free of silicones.

## DIMENSIONS

Roof opening width W: 500 - 1250 mm  
Roof opening length L: 500 - 3000 mm

## OPENING ANGLE

Individual adjustable from 0° up to 85°

## CONTROLS NATURAL VENTILATION

P2 - Double pipe compressed air operation  
M230V Electric motor

## CONTROLS FIRE VENTILATION

P2F double pipe compressed air operation with fire function  
M24/48V Electric motor

## FLAPS

- AL** Single aluminium
- AL ISO** Double insulated aluminium (20 and 50 mm)
- PC16** Polycarbonate 16mm, clear or opal
- PC25** Polycarbonate 25mm, clear or opal
- PC32** Polycarbonate 32mm, clear or opal
- TB** Thermal break in the aluminium profiles. Available for flaps of AL ISO, PC25 mm, PC32 mm



**PC16**

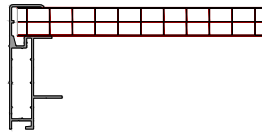

**PC25**

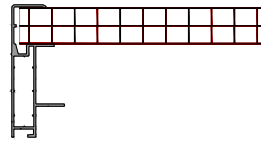

**PC32**

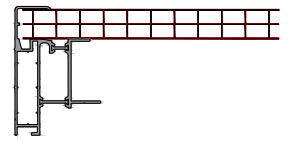

**PC25 TB**

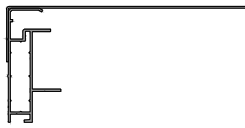

**AL**



**AL ISO 20**

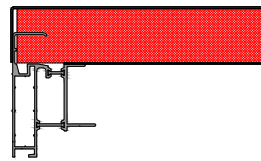

**TB AL ISO 50**

## BASES

- Single aluminium
- Double insulated aluminium
- Double insulated aluminium and TB, thermal break in the aluminium base
- Other non-standard bases available upon request

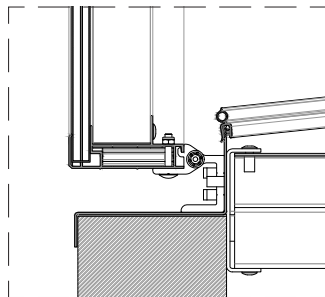

**DETAIL 01**  
standard aluminium

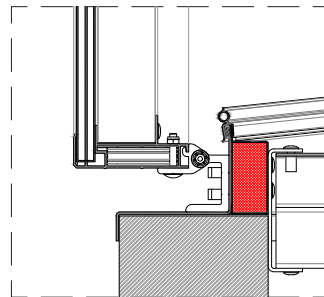

**DETAIL 02**  
insulated aluminium

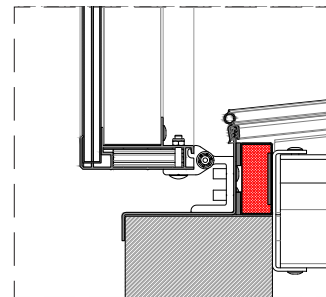

**DETAIL 03**  
double insulated aluminium  
and TB

## FLANGES

- S1** Flange for single glass
- S2** Flange for double glass
- S3** Flange for roofs, 45° bended
- S4** Flange for roofs and facades
- S5** Flange for upstand, 90° bended downwards
- S6** Flange 90° bended upwards
- SLS** Flange for skylight connection, for different polycarbonate thicknesses
- SC** Flange for connection with other flange (vents connection). Male or female connection
- SCM** Flange for male connection
- SCF** Flange for female connection

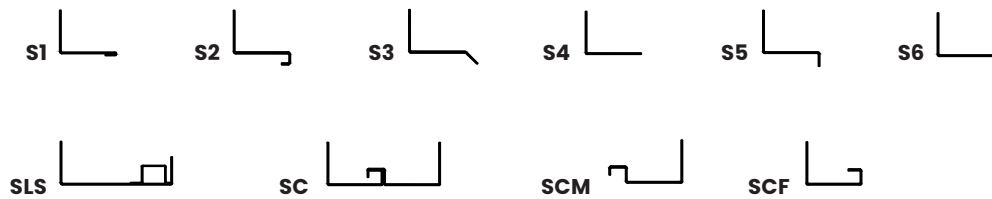

## WEIGHT

Depends on dimensions and type of infill

## OPTIONS

Custom dimensions / Powder-coated design (any RAL colour) / Bird or insect mesh/Anti-fall grid 1200 J.

## REGULATIONS

The system has been tested and is certified in accordance with EN 12101-2

|                           |                |                |
|---------------------------|----------------|----------------|
| <b>WIDTH</b>              | 500 up to 850  | 851 up to 1250 |
| <b>STROKE</b>             | 575 mm         | 800 mm         |
| <b>PNEUMATIC CYLINDER</b> | PVZ 40-00      | PVZ 40-00      |
|                           | -              | PVZ 50-00      |
| <b>ELECTRIC MOTOR 2A</b>  | JM - DC3 900N  | JM - DC3 900N  |
| <b>ELECTRIC MOTOR 4A</b>  | JM - DC3 1600N | JM - DC3 1600N |

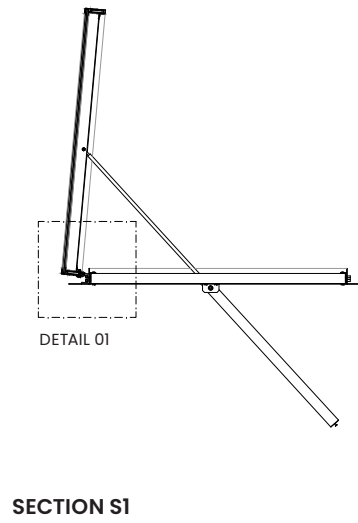
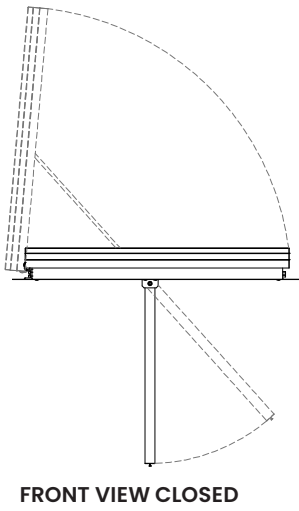
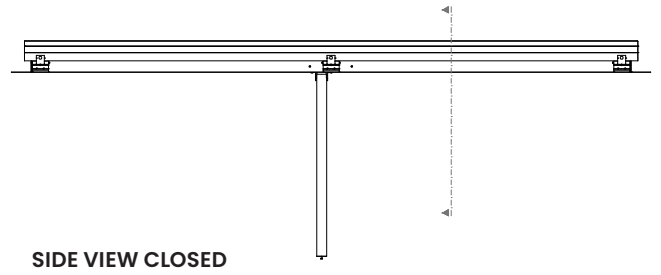
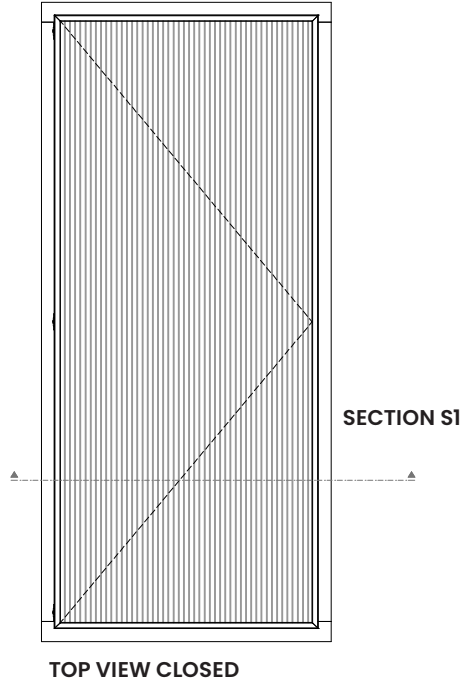

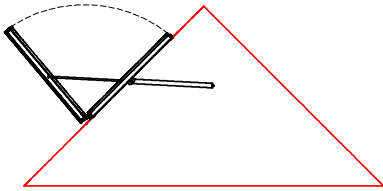

SECTION S2

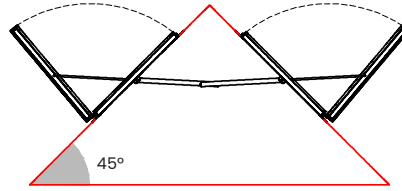

SECTION S3

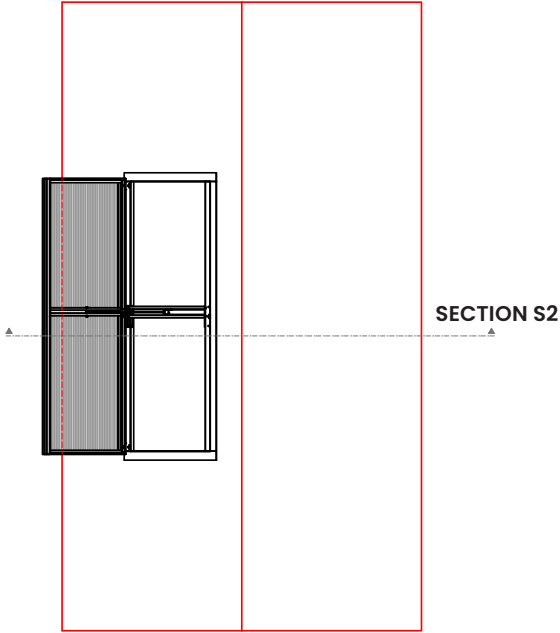

TOP VIEW

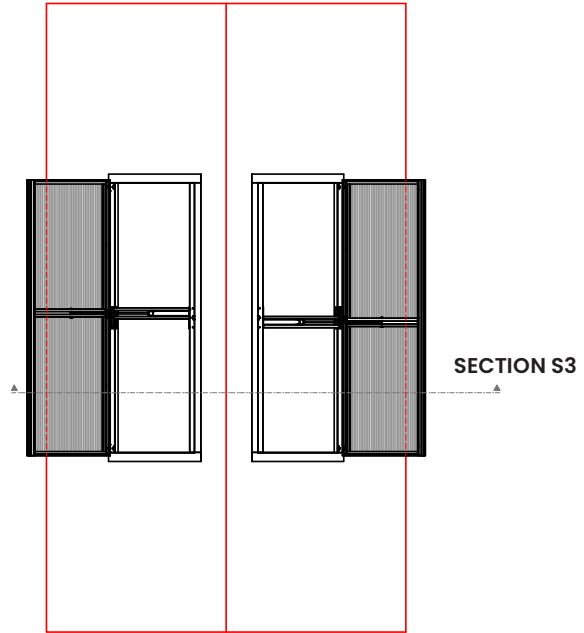

TOP VIEW

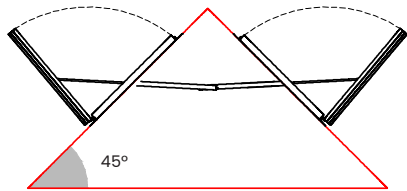

SECTION S4

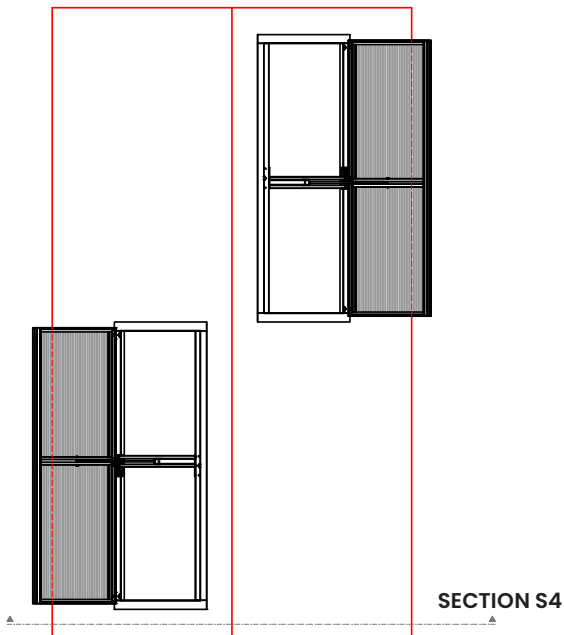

TOP VIEW